

RVS-AX

Analog Soft Starter
8-170A, 220-600V



Instruction Manual

Ver. 02/12/2007

RVS-AX Instruction Manual

1. TABLE OF CONTENT

1.	Table of Content	2
2.	Safety & Warnings	3
2.1	Safety	3
2.2	Attention	3
2.3	Warnings	3
3.	Technical Data	4
3.1	Introduction	4
3.2	Rating and frames sizes	4
3.3	Starter Selection	4
3.4	Mains and control description	5
3.4.1	Mains Voltage (line to line) (Terminals/bars L1, L2, L3)	5
3.4.2	Start (Terminals 1, 2)	5
3.4.3	Neutral (Terminal 3)	5
3.4.4	Open terminal (Terminal 4)	5
3.4.5	End Of Acceleration (terminals 5, 6)	5
3.4.6	Fault Contact (terminals 7, 8)	5
3.5	Built-in Bypass (RVS-AX31A and higher)	6
3.6	Soft starter protections	6
3.6.1	Electronic Overload	6
3.6.2	Phase Loss	6
3.6.3	Heatsink over temperature protection	6
3.6.4	Fault Logic and Reset Circuits	7
3.7	Starter selection tables for various voltage ratings	7
3.7.1	Ordering Information	8
4.	Recommended Wiring Schemes	9
4.1	Typical wiring diagram	9
4.2	Wiring Notes	9
4.2.1	Short Circuit Protection	10
4.2.2	Transient Protection	10
5.	Dimensions	11
6.	Installation	13
6.1	Prior to Installation	13
6.2	Mounting	13
6.3	Temperature range & heat dissipation	13
6.3.1	Heat dissipation during RUN of RVS-AX8A and RVS-AX17A (No internal bypass)	13
6.3.2	Calculating the enclosure size, for non-ventilated metallic enclosure	14
6.3.3	Additional Ventilation	14
7.	Front Panel	15
7.1	Potentiometers settings	15
7.2	Indication LEDs and RESET button	17
8.	Starting Procedure	18
8.1	Standard starting procedure	19
8.2	Examples of starting curves	20
9.	Trouble Shooting	21
9.1	Warranty Claim and Fault Inquiry	22
10.	Technical Specifications	23

2. SAFETY & WARNINGS

2.1 Safety

	1	Read this manual carefully before operating the equipment and follow its instructions.
	2	Installation, operation and maintenance should be in strict accordance with this manual, national codes and good practice.
	3	Installation or operation not performed in strict accordance with these instructions will void manufacturer's warranty.
	4	Disconnect all power inputs before servicing the soft-starter and/or the motor.
	5	After installation, check and verify that no parts (bolts, washers, etc.) have fallen into the starter.
	6	During shipping, the soft-starter might have been roughly handled, therefore, it is recommended to initialize the soft-starter by connecting supply voltage prior to operating the soft-starter with a motor

2.2 Attention

	1	This product was designed for compliance with IEC 947-4-2 for class A equipment.
	2	Use of the product in domestic environments may cause radio interference, in which case, the user may be required to employ additional mitigation methods.
	3	Utilization category is AC-53a or AC53b, Form 1. For further information, see Technical Specification

2.3 Warnings

	1	Internal components and P.C.Bs are at mains potential when the RVS-AX is connected to mains. This voltage is extremely dangerous and will cause death or severe injury if contacted.
	2	When RVS-AX is connected to mains, even if start command has not been issued and motor is stopped, full voltage may appear on starter's output and motor's terminals. Therefore, for isolation purposes it is required to connect an isolation device upstream to the RVS-AX.
	3	The starter must be properly grounded to ensure correct operation, safety and to prevent damage.
	4	Check that Power Factor capacitors are not connected to the output side of the soft starter.
	5	Do not interchange line and load connections

The company reserves the right to make any improvements or modifications to its products without prior notice.

3. TECHNICAL DATA

3.1 Introduction

The RVS-AX electronic soft starter incorporates six thyristors (Three phase control) to start a three-phase squirrel cage induction motor and an internal bypass (Internal bypass in RVS-AX31A and higher). By supplying a slowly increasing voltage, it provides soft start and smooth stepless acceleration, while drawing the minimum current necessary to start the motor.

A Soft Stop feature can be enabled when the Ramp-Down potentiometer is adjusted. When used, upon stop Signal, motor's voltage is slowly reduced to zero.

The RVS-AX incorporates a built in motor protection of Overload protection and Phase loss protection.

The RVS-AX incorporates an internal protection to protect its heatsinks from over heating.

No control voltage is required to operate the RVS-AX.

3.2 Rating and frames sizes

RVS-AX model	FLC [A]	Dimensions WxHxD [mm]	Weight [kg]	EOA Relay	Fault Relay	Internal bypass
RVS-AX 8	8	120x232x105	2.6	✓	✓	No
RVS-AX 17	17	120x232x105	2.6	✓	✓	No
RVS-AX 31	31	120x232x105	2.6	✓	✓	✓
RVS-AX 44	44	120x232x105	2.6	✓	✓	✓
RVS-AX 58	58	129x275x185	5	✓	✓	✓
RVS-AX 72	72	129x275x185	5	✓	✓	✓
RVS-AX 85	85	120x380x185	8.4	✓	✓	✓
RVS-AX 105	105	120x380x185	8.4	✓	✓	✓
RVS-AX 145	145	172x380x195	11.8	✓	✓	✓
RVS-AX 170	170	172x380x195	11.8	✓	✓	✓

Notes:

- (✓) – Standard
- Refer to section 5 on page 11 for detailed dimensions.

3.3 Starter Selection

Select the starter according to motor's Full Load Ampere (FLA) - as indicated on its nameplate (even if the motor will not be fully loaded).

The RVS-AX is designed to operate under the following maximum conditions:

Ambient Temperature [°C]	Starting Current [A]	Acceleration Time [sec]
40	300% \times In	30
	350% \times In	20
	400% \times In	5

Max. starts per Hour: four (4) starts per hour at maximum ratings and up to 10 starts per hour at light load applications (consult factory).

Note:

For very frequent starts (inching applications) the inching current should be considered as the Full Load Current (FLC) (consult factory).

3.4 Mains and control description

3.4.1 Mains Voltage (line to line) (Terminals/bars L1, L2, L3)

Five mains voltage levels are available: 230V, 400V, 440, 480V, 600V.

Note:

230	220 - 240 Vac +10% -15%
400	380 - 415 Vac +10% -15%
440	440 Vac +10% -15%
480	460 - 500 Vac +10% -15%
600	575 - 600 Vac +10% -15%

3.4.2 Start (Terminals 1, 2)

Start/Stop command is initiated by closing/opening a voltage free contact (Dry contact)

Close: Start command.

Open: Stop command.

WARNING!	Never apply voltage to terminals 1, 2.
	Start/Stop with a maintained contact!
	When the line contactor is operated by a maintained contact, in case of Mains failure, the motor will be automatically restarted upon voltage restoration!

3.4.3 Neutral (Terminal 3)

Neutral wire (when used) is required only for operation of the Phase Loss Protection (Phase Loss can not be detected when Neutral is not connected to Terminal 3).

See detailed description in "Phase Loss" explanation section 3.6.2 page 6 .

3.4.4 Open terminal (Terminal 4)

This terminal is of no use. Leave this terminal not connected.

3.4.5 End Of Acceleration (terminals 5, 6)

Voltage free, N.O., 8A / 250VAC, 1800VA max.

The contact closes after the time adjusted on the "Ramp-Up" potentiometer. The contact returns to its original position on stop signal, on fault condition, upon voltage outage and at the beginning of Soft Stop.

This contact can be used for:

- Activating a valve after a compressor has reached full speed.
- Activating a valve after a pump has reached full speed.
- Loading a conveyor after the motor has reached full speed.

3.4.6 Fault Contact (terminals 7, 8)

Voltage free, N.O , 8A, 250VAC, 1800VA max.

The contact changes its position upon fault and returns to its original position after fault has been removed and starter was reset. When disconnection of mains supply the contacts will be opened.

WARNING!	Do not use the Fault contact to trip an upstream contactor! When the Fault contact trips the upstream contactor, Mains voltage will be disconnected, thus resetting the starter and the motor will restart instantaneously upon voltage restoration. (See also section 3.6.4 on page 7).
	When resetting after a fault with the Reset button, the motor will restart upon fault reset. It is therefore recommended not to connect the fault relay to the line contactor.

3.5 Built-in Bypass (RVS-AX31A and higher)

The RVS-AX (31A model and higher) incorporates three internal bypass relays allowing current flow through the thyristors only during starting process. At the end of the starting process, the built-in relays bypass the thyristors and carry the current to the motor.

Upon stop signal, or in case of fault, bypass relays will open and stop the motor.

When Ramp-Down potentiometer is set to allow soft-Stop process, upon stop command, the bypass relays will open immediately and the current will flow through the thyristors. The voltage will then be reduced slowly and smoothly to zero.

3.6 Soft starter protections

3.6.1 Electronic Overload

The built-in inverse time electronic overload becomes operational after end of acceleration process.

Trip current is factory set to 115% of Motor Full Load Current (from the setting on Motor FLC potentiometer), E.g. In order to increase the O/L trip point increase FLC setting above the calculated level.

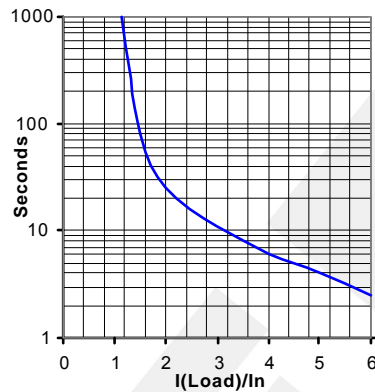

Electronic overload curve

When this protection activates Overload LED on the front panel will light.

3.6.2 Phase Loss

The protection becomes operational when the starter is energized.

It protects the motor from single phasing. It will trip the starter when one phase is missing for more than 1 sec. When this protection activates Phase Loss LED on the front panel will light.

Notes:

- Phase loss protection operates only when Terminal 3 is connected to Neutral.
- When phase loss occurs during starting or when motor is not loaded, it may happen that motor will stop without accurate indication of the Phase Loss LED.

3.6.3 Heatsink over temperature protection.

The protection becomes operational when the starter is energized.

It protects the soft starter from over heating.

A thermal sensor mounted on the heatsink trips the starter when its heatsink temperature rises above 85°C. When this protection activates Over-temp LED on the front panel will light.

WARNINGS!

The heatsink over temperature protection is designed to operate under normal conditions and will operate in case abnormal conditions occur:

- Incorrect starter selection
- Too frequent starting at maximum conditions
- Repeated starting under fault conditions
- Extended low overload
- Insufficient ventilation
- Other abnormal conditions

Note:

In case of frequent starting the internal thyristors may overheat before the heatsink reaches its over-temperature protection of 85°C, thus causing component malfunction.

3.6.4 Fault Logic and Reset Circuits

Upon operation of any protection, the starter locks in a fault mode, disabling thyristors firing. The proper fault indication LED lights and the Fault contact closes.

To reset the starter, after the fault has been removed, press Reset button on starter's front panel or disconnect Mains voltage.

WARNING!

When starter is operated by a maintained contact, resetting the fault will start the motor immediately!

Do not use the Fault contact to trip an upstream contactor. When the Fault Contact closes on fault and trips the upstream contactor, Mains voltage will be disconnected, thus resetting the RVS-AX and the motor will restart instantaneously (see Fault Resetting).

3.7 Starter selection tables for various voltage ratings.

1	The starter selection table below concern standard, 1500r.p.m. 50Hz, three-phase motors.
2	These values are given for guidance and may vary according to motor manufacturer and depending on the number of poles.
3	It is the user's responsibility to make sure that motor's FLA will never exceed Starter's FLC.

Starter model	Starter FLC [A]	Motor kW @230V [kW]	Motor kW @400V [kW]	Motor kW @480V [kW]	Motor kW @600V [kW]
RVS-AX 8	8	1.5	3	4	5.5
RVS-AX 17	17	4	8	9	12.5
RVS-AX 31	31	8	15	18.5	25
RVS-AX 44	44	12.5	22	25	30
RVS-AX 58	58	15	25	37	45
RVS-AX 72	72	20	37	45	59
RVS-AX 85	85	25	45	55	59
RVS-AX 105	105	30	55	59	80
RVS-AX 145	145	40	75	90	110
RVS-AX 170	170	51	90	110	140

3.7.1 **Ordering Information****RVS-AX****31-**
Full load
Current**400-**
Mains
Voltage**0-**
Options**S**
Front
Panel**Full load Current**

Specify	Description
Starter's FLC [A]	8 ⁽¹⁾ , 17 ⁽¹⁾ , 31, 44, 58, 72, 85, 105, 145, 170

Mains Voltage

Specify	Description
230	220 - 240 Vac +10% -15%
400	380 - 415 Vac +10% -15%
440	440 Vac +10% -15%
480	460 - 500 Vac +10% -15%
600	575 - 600 Vac +10% -15%

Options

Specify	Description
0	No options
8	Harsh environment treatment

Front Panel

Specify	Description
S	Standard lexan

Notes:⁽¹⁾ No internal bypass in RVS-AX 8, 17A.**Example:**RVS-AX rated 145A, mains voltage- 208V, harsh environment treatment and standard front panel:
RVS-AX 145 - 208 - 8 - S

4. RECOMMENDED WIRING SCHEMES

4.1 Typical wiring diagram

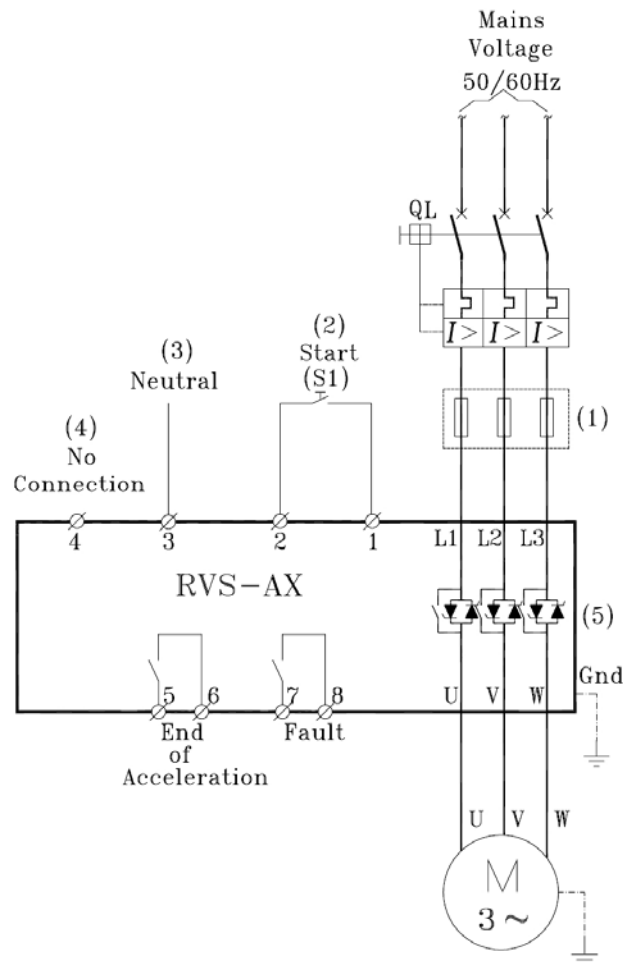

Notes:

- (1) - Use fuses for type 2 coordination. Refer to section 4.2.1 on page 10
 (2) – Use a maintained contact to start the motor. Open the contact to soft stop/stop the motor. Contact must be closed one second after voltage at L1, L2, L3 is stable.

Never apply voltage to terminals 1 & 2.

- (3) – Connect terminal 3 to system neutral. If not connected to neutral, phase loss protection might not function as required. Refer to section 3.6.2 on page 6.
 (4) – Leave terminal 4 not connected.
 (5) – No internal bypass in RVS-AX8A and RVS-AX17A.

4.2 Wiring Notes

WARNINGS!

When mains voltage is connected to the RVS-AX, full voltage may appear on the starter load terminals. Therefore, for isolation purposes, it is necessary to connect an isolating device before the starter.

Power factor correction capacitors **must not** be installed on starters load side. When required, install capacitors on starter's line side.

Never connect the RVS-AX "Inside Delta"! (Consult factory)

When starter is operated by a maintained contact, resetting a fault will start the motor immediately!

When the line contactor is operated by a maintained contact, in case of Mains failure, the motor will be automatically restarted upon voltage restoration!

Do not use the Fault contact to trip an upstream contactor!

When the Fault contact trips the upstream contactor, Mains voltage will be disconnected, thus resetting the starter and the motor will restart instantaneously upon voltage restoration!

4.2.1 **Short Circuit Protection**

For “class 2 coordination”, protect the starter against a short circuit by thyristor protection fuses for I^2t and fuses as in dictated in the following table:

RVS-AX type	I^2t (A ² S)	Ferraz Fuses
RVS-AX 8	400	6,6 URS 35
RVS-AX 17	2,000	6,6 URS 45
RVS-AX 31	3,000	6,6 URS 63
RVS-AX 44	6,000	6,6 URB 100
RVS-AX 58	12,000	6,6 URB 150
RVS-AX 72	18,000	6,6 URB 160
RVS-AX 85	40,000	6,6 URD 200
RVS-AX 105	60,000	6,6 URD 250
RVS-AX 145	100,000	6,6 URD 355
RVS-AX 170	140,000	6,6 URD 400

4.2.2 **Transient Protection**

Line transient voltages can cause a malfunction of the starter and damage to the thyristors. All RVS-AX starters incorporate Metal Oxide Varistors (MOV) to protect from normal line voltage spikes.

When higher transients are expected, additional external protection should be used (consult factory).

5. DIMENSIONS

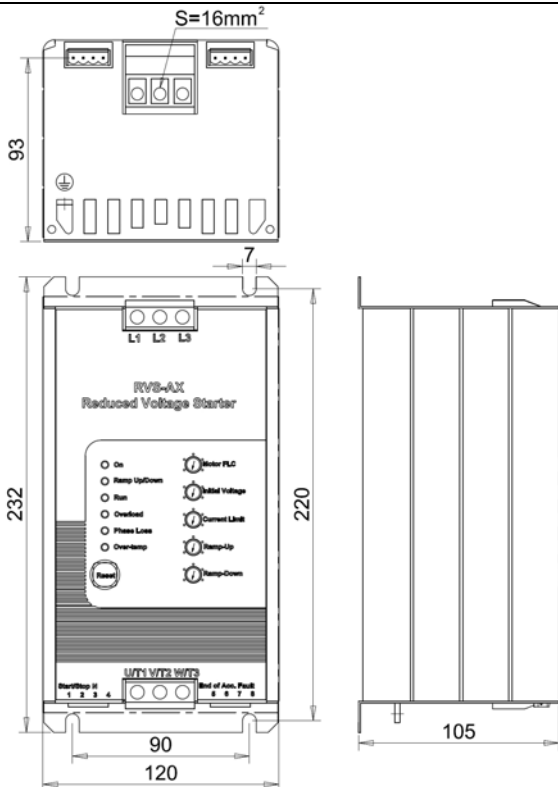

RVS-AX 8, 17, 31, 44

Note: Mains voltage terminals: 16mm²

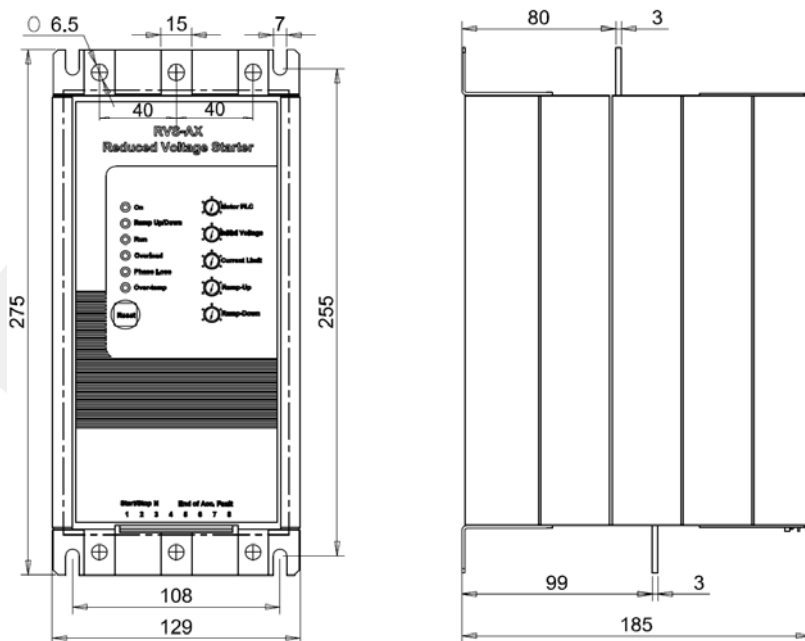
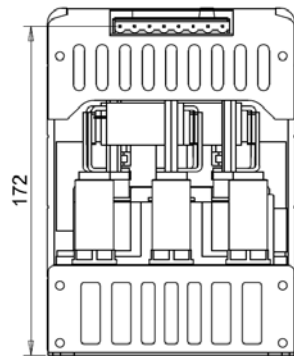

RVS-AX 58, 72

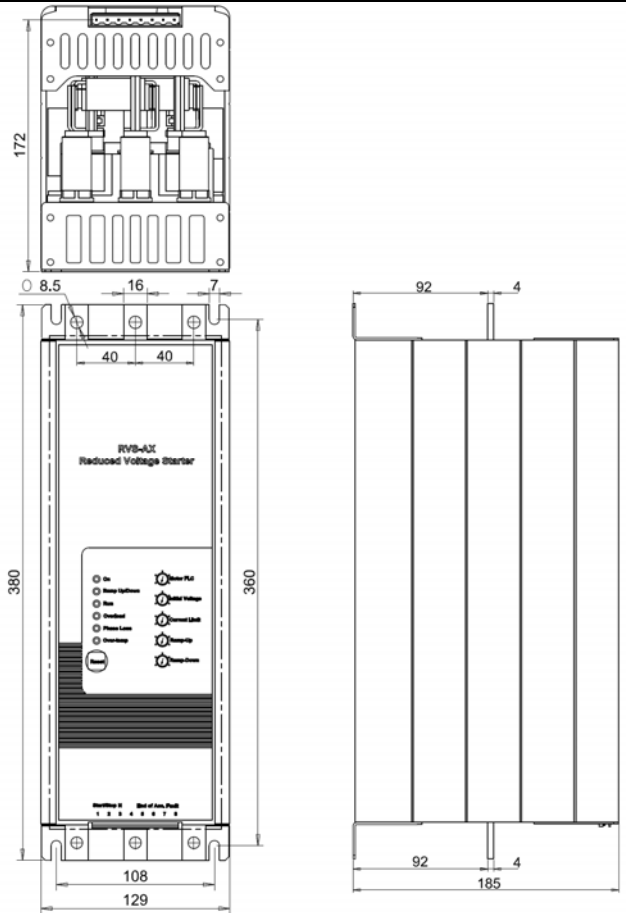

RVS-AX 85, 105

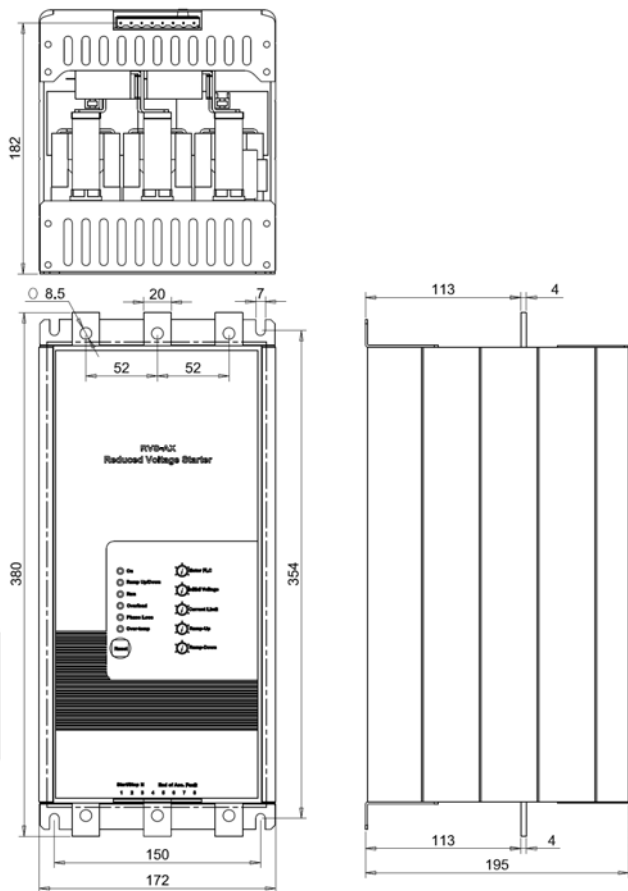

RVS-AX 145, 170

6. INSTALLATION

WARNING!

Do not interchange line and load connections

Do not connect the RVS-AX "Inside Delta" (consult factory)

6.1 Prior to Installation

Check that Motor's Full Load Ampere (FLA) is lower than, or equal, to the starter's Full Load Current (FLC) and that Mains and Control voltages are as indicated on the starter's side label.



RVS-AX label - example

Make sure Starter's FLC ≥ Motor FLA!
 Make sure Mains voltage is right!
 Make sure control is by voltage free contact!

6.2 Mounting

The starter must be mounted vertically. Allow sufficient space (at least 100mm) above and below the starter for suitable airflow.

It is recommended to mount the starter directly on the rear metal plate for better heat dissipation.

Do not mount the starter near heat sources.

Surrounding air temperature in the cabinet should not exceed 40°C

Protect the starter from dust and corrosive atmospheres.

Note: For harsh environments (sewage treatment plants, etc.), it is recommended to order the starter with printed circuit board coating. Refer to section 3.7.1 on page 8 for ordering information.

6.3 Temperature range & heat dissipation

The starter is rated to operate over a temperature range of -10°C (14°F) to + 40°C (104°F).

Relative non-condensed humidity inside the enclosure should not exceed 95%.

ATTENTION!

Operating at surrounding air temp. (Inside the cabinet) higher than 40°C may cause damage to the starter.

Starter's heat dissipation while motor is running and the internal bypass relays are closed (RVS-AX31A and higher) is typically less than $0.4 \times I_n$ (in watts).

During soft start and soft stop, heating is approximately two times the actual starting current (I_n watts).

Example: For a 100A motor, heat dissipation is less than 40 watts while running.

Important note: If motor is frequently started, cabinet should be designed for the higher heat dissipation.

Internal enclosure heating can be reduced through the use of additional ventilation.

6.3.1 Heat dissipation during RUN of RVS-AX8A and RVS-AX17A (No internal bypass)

Heat dissipation from the RVS-AX8A and RVS-AX17A when external bypass is not applied is calculated as:

$$P_{loss} = 3 \times 1.3 \times I$$

Where:

I – motor current

For example:

During run of RVS-AX17A when motor current is 17A heat dissipation can be calculated as:

$$P_{loss} = 3 \times 1.3 \times 17 = 66.3 \text{ Watt}$$

6.3.2 **Calculating the enclosure size, for non-ventilated metallic enclosure**

$$\text{Area (m}^2\text{)} = \frac{0.12 \times \text{Total heat dissipation [Watts]}}{60 - \text{External ambient temp. [}^\circ\text{C]}}$$

Where: **Area [m²]** - Surface area that can dissipate heat (front, sides, top).

Total heat dissipation [Watt] – The total heat dissipation of the starter and other control devices in the enclosure. If starter is frequently started, average power should be used.

6.3.3 **Additional Ventilation**

Use the following arrangement for forced ventilation of the RVS-AX's enclosure:

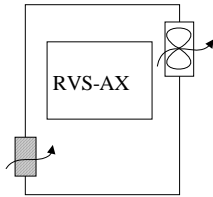

General purpose enclosure with filter on the air inlet and Fan on air outlet.

7. FRONT PANEL

The RVS-AX front panel contains:

- (1) Five potentiometers for setting: Motor FLC, Initial Voltage, Current Limit, Ramp Up and Ramp Down.
- (2) Six indication LEDs: On, Ramp Up/Down, Run, Overload, Phase loss, Over temperature
- (3) Reset Button

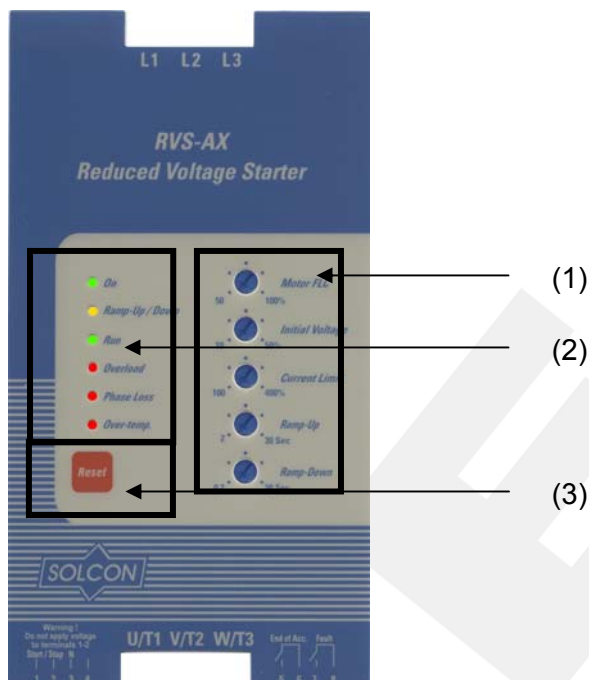





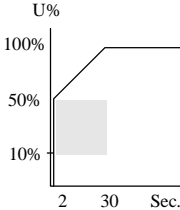
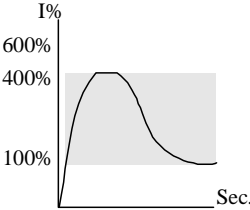
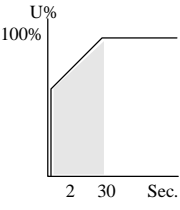

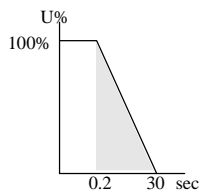
7.1 Potentiometers settings

Potentiometer	Range	Description
Motor FLC	50-100%	<p>The adjustment allows easy setting of the RVS-AX current level, automatically adjusting current based functions (Overload, Current Limit, etc).</p> <p>Set FLC potentiometer according to the following equation:</p> $FLC = \frac{\text{Motor FLA}}{FLC} \times 100$ <p>Where:</p> <p>Motor FLA is the motor's Full Load Current rating as shown on its nameplate.</p> <p>FLC is the starter Full Load Current as shown on its label.</p> <p>Example:</p> <p>When starting a 27A motor using RVS-AX 31:</p> $FLC\% = \frac{27}{31} \times 100 = 87\%$ <p>Therefore set the FLC% to a reading of 87% (see Ex.)</p>

Potentiometer	Range	Description
Initial Voltage	10-50%	<p>Determines the initial voltage to the motor (torque is directly proportional to the square of the voltage). Range: 10-50% of nominal voltage. This adjustment also determines the inrush current and mechanical shock. Too high of a setting may cause high initial mechanical shock and high inrush current (even if Current Limit is set low, as the Initial Voltage setting over-rides the Current Limit setting). Too low of a setting may result in prolonged time until motor starts revolving. The motor should start revolving immediately after Start signal</p> 
Current Limit	100-400%	<p>Determines motor's highest current during starting. Range is 100-400% of FLC (as set on motor's FLC adjustment). Too high of a setting will allow higher currents to be drawn from mains, resulting in faster acceleration. Too low of a setting may prevent the motor from completing the acceleration process and reaching full speed. Generally, this setting should be set to the highest acceptable value in order to prevent stalling.</p>  <p>Caution Starting Current and time should not exceed the allowable conditions as shown on section 3.3 on page 4.</p>
Ramp Up	2-30 sec.	<p>Determines motor's voltage ramp-up time from initial to full voltage. It is recommended to set Ramp-Up Time to the minimum acceptable value (approx. 5 Sec).</p> <p>Notes:</p> <ol style="list-style-type: none"> Setting Current Limit low will extend Ramp-Up Time. When motor reaches full speed before voltage reaches nominal, Ramp-Up Time adjustment is overridden, causing voltage to quickly ramp up to nominal. 

Potentiometer	Range	Description
Ramp Down	0.2-30 sec.	<p>Used to control deceleration of high friction loads. When Ramp-Down potentiometer is set, upon stop signal the starter output voltage is gradually ramped down.</p> <p>When "Ramp-down Time" is set to minimum, the motor will stop immediately.</p> 

7.2 Indication LEDs and RESET button

	Green	<i>On</i>	Will lit when Mains voltage is connected to the starter.
	Yellow	<i>Ramp Up/Down</i>	Will lit during soft start and soft stop process, indicating that motor supply voltage is ramping up or down.
	Green	<i>Run</i>	Will lit after completion of starting process, indicating that motor is receiving full voltage.
	Red	<i>Overload</i>	Will lit upon operation of the built-in overload protection.
	Red	<i>Phase Loss</i>	Will lit upon operation of the phase loss protection.
	Red	<i>Over-temp</i>	Will lit upon operation of the heatsink over temperature protection.
		<i>Reset Button</i>	To reset the starter, after the fault has been removed.

8. **STARTING PROCEDURE**

	1	When mains voltage is connected to the RVS-AX, even if start signal has not been issued, full voltage may appear on the starter load terminals. Therefore, for isolation purposes, it is necessary to connect an isolating device before (upstream) the starter.
	2	Power factor correction capacitors must not be installed on starters load side. When required, install capacitors on starter's line side.
	3	Before starting the motor verify its rotation direction. If needed, disconnect the rotor from the mechanical load and verify the right rotation direction.
	4	Prior to Start up procedure make sure that line voltage match the one shown on the starter's name plate.
	5	Do not interchange line and load connections
	6	Do not connect the RVS-AX "Inside delta". (Consult factory)

8.1 Standard starting procedure

1. Set FLC (Motor Full Load Current) - according to calculation:

$$FLC = \frac{\text{Motor FLA}}{\text{Starter FLC}} \times 100$$

2. Set other potentiometers according to system requirements (see next page for examples)
3. Connect mains voltage to starter line terminals. On LED will light.
4. Apply Start command

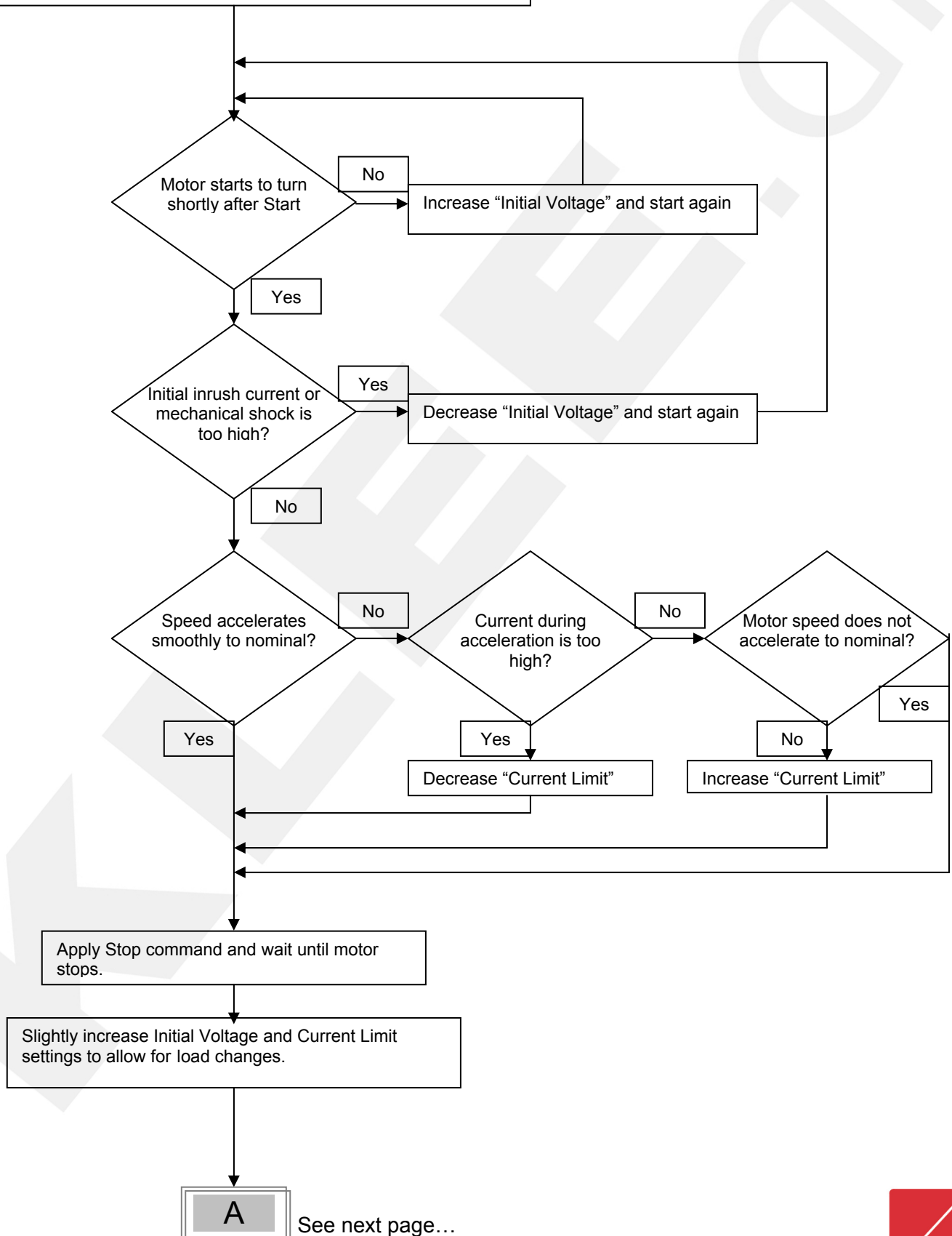

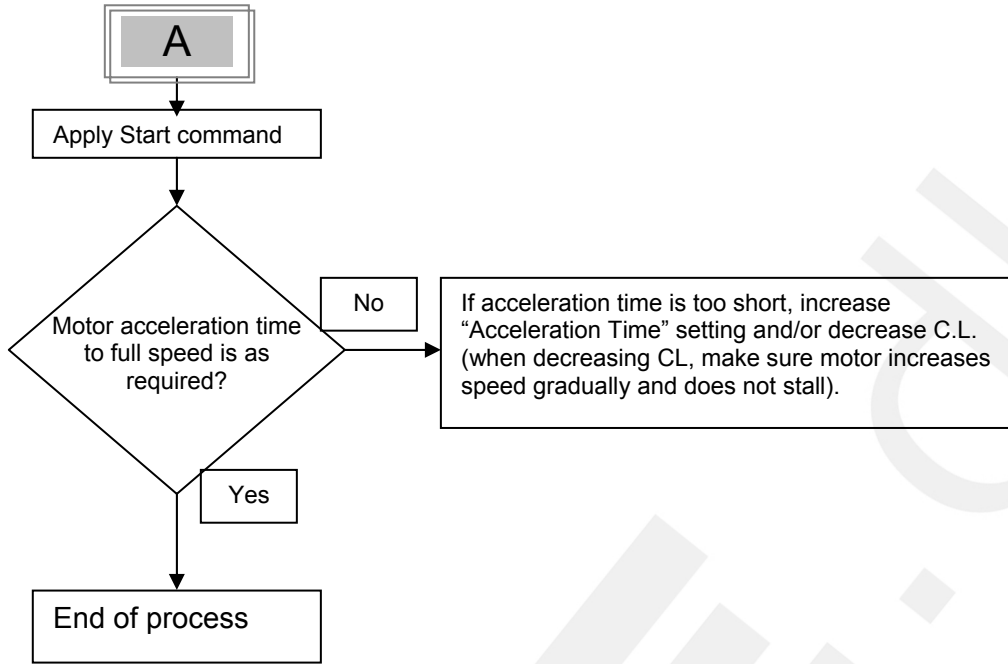

8.2 Examples of starting curves

Light loads - pumps, etc.

(In these cases actual current is always less than Current limit setting)

Current limit - set to 300-350%

Initial Voltage - set to 30%

Ramp-up time - set to 10 sec.

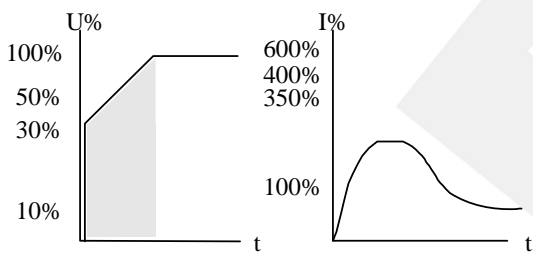

Upon start, the voltage quickly increases to the Initial Voltage value (30% of U_n) and then gradually ramps-up to nominal.

The current will simultaneously increase to peak current value (Lower than the current Limit setting), before smoothly decreasing to the operating current.

High inertia loads – crushers, centrifuges, mixers etc.

(In these cases actual current is at Current limit setting in part of the starting time)

Current Limit - set to 400%

Initial Voltage - set to 40%

Ramp-Up time - set to 3 sec.

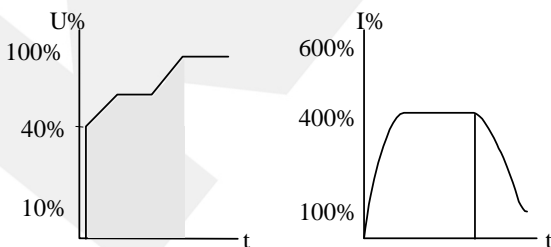

Upon start the voltage and current increase until current reaches Current Limit value. The voltage remains at this value until motor reaches close to nominal speed, where current starts to decrease, voltage continues to ramp-up to nominal.

9. TROUBLE SHOOTING

Upon fault – motor stops, *Fault* LED lights and Fault Relay operates.

Fault Message	Cause and trouble shooting
Overload LED lights.	<p>Trips the starter when current exceeds the overload level and thermal register has filled up.</p> <p><i>Check FLA, FLC and Overload settings, check motor current, wait at least 15 minutes to let motor and starter cool down before restarting.</i></p>
Phase Loss LED lights	<p>Trips when phase loss protection has activated.</p> <p><i>Check that all 3 phases are within voltage limits.</i></p>
Over temp LED lights	<p>Heat-sink over-temperature. Trips the starter when heat-sink temp. rises above 85°C.</p> <p><i>Check that motor starting is not too frequent, check ventilation and surrounding air temperature.</i></p>

9.1 Warranty Claim and Fault Inquiry

Representative Name:	Country:	Fax Number:
Model Number And Build Options:	Example: 170 – 400 – 8 – S RVS-AX - - - -	
Serial Number:		
Purchasing Date:		
Sale / Installation Date:		
Failure Date:		
Draw one line diagram:		
Draw control diagram:		
Define time of fault occurrence: (during start, after start, during soft stop, end of soft stop, when closing ByPass.....)	23	
Starter Operative Information		
Starter FLC:		
Motor FLC:		
Initial Voltage:		
Acceleration Time:		
Current Limit:		

10. TECHNICAL SPECIFICATIONS

Environment		
Supply voltage	230 220 - 240 Vac +10% -15% 400 380 - 415 Vac +10% -15% 440 440 Vac +10% -15% 480 460 - 500 Vac +10% -15% 600 575 - 600 Vac +10% -15%	
Frequency	50 / 60 Hz	
Load	Three-Phase, Three-Wire, Squirrel Cage Induction Motor	
Degree of protection	RVS-AX 8-44A: IP 20 RVS-AX 58-170A: IP 00	
Altitude	1000 m above sea level	Consult factory for derating
Adjustments		
FLC (Full Load Current)	50% - 100%	
Starting Torque (Initial Voltage)	10-50 % of full voltage	
Current limit	100 % - 400% of nominal current	
Ramp Up Time (soft start)	2 - 30 sec.	
Ramp Down Time (Soft Stop)	0.2 - 30 sec.	
Protection		
Electronic Overload	Inverse time (I^2t), factory preset at 115% of FLC, active only during Run.	
Phase Loss	Trips when one phase is missing (When Neutral is connected)	
Heatsink Over temperature	Trips when the heatsink temperature exceeds 85°C.	
Reset buttons	To reset the starter, after the fault has been removed.	
Indications		
Indication lights (LEDs)	ON - Green	Lights when three phases are connected to the RVS-AX.
	Ramp Up / Ramp Down – Yellow	Lights upon start signal or during soft stopping.
	RUN – Green	Lights upon end of starting. When the internal bypass relays close. No internal bypass in RVS-AX8A & RVS-AX17A
	Overload – Red	Inverse time electronic overload becomes operational after the End Of Acceleration process.
	Phase loss – Red	Lights when one or two phases are missing for more than 1 sec.
	Over temperature – Red	Lights on and trips the starter when the heatsink temperature rises above 85°C.
Temperatures		
Operating	-10° to 40°C	
Storage	-20° to 70°C	
Relative humidity	93 % - non condensed	
EMC		
Immunity to radio electric interference	EN 1000-4-3 level 3	Conforming to EN 60947-4-2
Electrostatic discharge	EN 1000-4-2 level 3	Conforming to EN 60947-4-2
Immunity to electrical transients	EN 1000-4-4 level 4	Conforming to EN 60947-4-2
Shock waves of voltage / current	EN 1000-4-5 level 3	Conforming to EN 60947-4-2
Radiated and conducted emissions	EN 1000-4-6 level 3	
Radio frequency emissions	According to EN 55011 class A	Conforming to EN 60947-4-2
Mechanical		

